

# Connector Plugs

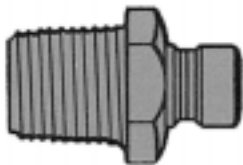

• Male Thread Plugs •  
(Brass)

Part Number	Flow Diameter	Pipe Thread	Price	Part Number	Flow Diameter	Pipe Thread	Price	Part Number	Flow Diameter	Pipe Thread	Price
MP-250	3/16	1/16	1.20	MP-351	1/4	1/8	1.03	MP-552	3/8	1/4	2.61
MP-251	1/4	1/8	.45	MP-352	3/8	1/4	.55	MP-553	1/2	3/8	2.61
MP-252	1/4	1/4	.50	MP-353	3/8	3/8	.66	MP-554	5/8	1/2	1.80
MP-253	1/4	3/8	.95	MP-354	3/8	1/2	.97	MP-556	5/8	3/4	1.96

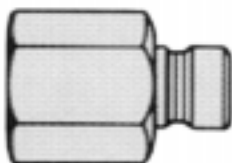

• Female Thread Plugs •  
(Zinc Plated Steel)

Part Number	Flow Diameter	Pipe Thread	Price	Part Number	Flow Diameter	Pipe Thread	Price	Part Number	Flow Diameter	Pipe Thread	Price
MP-251F	1/4	1/8	.71	MP-352F	3/8	1/4	.80	---	---	---	---
MP-252F	1/4	1/4	.76	MP-353F	3/8	3/8	1.01	MP-554F	5/8	1/2	3.91
MP-253F	1/4	3/8	1.14	MP-354F	3/8	1/2	2.53	MP-556F	5/8	3/4	6.67

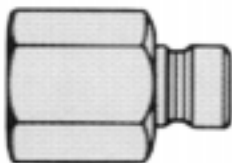

• Female Thread Plugs •  
(Brass)

Part Number	Flow Diameter	Pipe Thread	Price	Part Number	Flow Diameter	Pipe Thread	Price	Part Number	Flow Diameter	Pipe Thread	Price
MP-250FB	1/4	1/16	.95	MP-351FB	11/32	1/8	1.03	MP-552FB	7/16	1/4	2.50
MP-251FB	1/4	1/8	.86	MP-352FB	3/8	1/4	.73	MP-553FB	9/16	3/8	2.60
MP-252FB	1/4	1/4	.74	MP-353FB	3/8	3/8	.90	MP-554FB	5/8	1/2	2.60
MP-253FB	1/4	3/8	.93	MP-354FB	3/8	1/2	1.76	MP-556FB	5/8	3/4	4.61

# Brass Extension Plugs

- Connects plugs to steel pipe nipples without soldering or welding problems.
- Pre-cut pipe thread makes adjustments quick and easy.
- Protects sealing surface.
- Provides leak-free performance.
- Easily installed or removed.
- Available in many standard lengths and thread sizes.

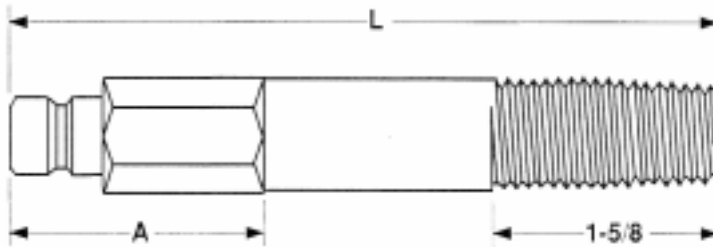

Standard Pipe Thread Data							
Pipe Size	Threads Per Inch	O.D.	I.D.	Tap Drill Size		Minimum Tap Drill Depth	Normal Thread Engage For Tight Joint
				W/O Ream	W/ Ream		
1/16	27	.312	.209	1/4	15/64	9/16	.261
1/8	27	.405	.269	11/32	21/64	5/8	.263
1/4	18	.540	.364	7/16	27/64	13/16	.395
3/8	18	.675	.493	37/64	9/16	7/8	.407
1/2	14	.840	.622	23/32	11/16	1-1/16	.534
3/4	14	1.050	.824	29/32	57/64	1-1/16	.545
1	11-1/2	1.315	1.049	1-9/64	1-1/8	1-3/8	.661

Extension Series	(D) Counterbore	(B) Depth
250	3/4	1
251	7/8	1-1/4
252	1	1-1/2
253	1-1/8	1-1/2
350	1	1-1/4
351	1	1-1/4
352	1	1-1/2
353	1-1/8	1-1/2
354	1-1/2	1-3/4
553	1-3/8	1-5/8
554	1-1/2	1-3/4

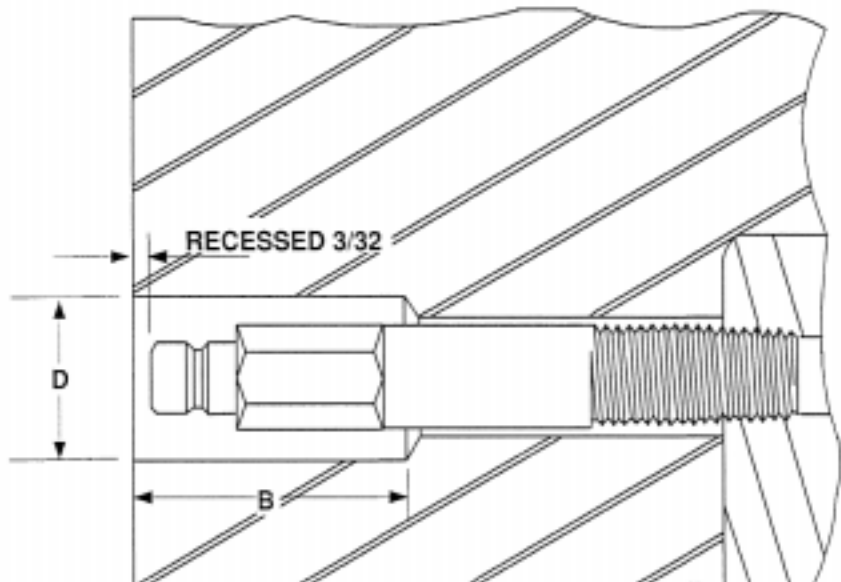

# Brass Extension Plugs

- Specifications For Extension Plugs Listed Below Are Found On Previous Page •
- Longer Lengths Or Special Extensions Are Available •

200 Series					
Part Number	(L) Length	Pipe Thread Size	Hex Size	(A)	Price
MP250X2-1/2	2-1/2	1/16	3/8	11/16	3.75
MP250X4	4	1/16	3/8	13/16	3.85
Part Number	(L) Length	Pipe Thread Size	Hex Size	(A)	Price
MP251X2-1/2	2-1/2	1/8	7/16	11/16	2.75
MP251X4	4	1/8	7/16	1	2.85
MP251X5-1/2	5-1/2	1/8	7/16	1	4.15
MP251X7	7	1/8	7/16	1	4.95
MP251X8-1/2	8-1/2	1/8	7/16	1	5.85
MP251X10	10	1/8	7/16	1	6.95
MP251X11-1/2	11-1/2	1/8	7/16	1	8.13
MP251X13	13	1/8	7/16	1	10.45
Part Number	(L) Length	Pipe Thread Size	Hex Size	(A)	Price
MP252X2-1/2	2-1/2	1/4	9/16	7/8	3.05
MP252X4	4	1/4	9/16	1-1/4	3.15
MP252X5-1/2	5-1/2	1/4	9/16	1-1/4	4.15
MP252X7	7	1/4	9/16	1-1/4	5.31
MP252X8-1/2	8-1/2	1/4	9/16	1-1/4	6.55
MP252X10	10	1/4	9/16	1-1/4	8.15
MP252X11-1/2	11-1/2	1/4	9/16	1-1/4	9.05
MP252X13	13	1/4	9/16	1-1/4	9.46
Part Number	(L) Length	Pipe Thread Size	Hex Size	(A)	Price
MP253X2-1/2	2-1/2	3/8	11/16	1	4.04
MP253X4	4	3/8	11/16	1-1/4	4.58
MP253X5-1/2	5-1/2	3/8	11/16	1-1/4	5.58
MP253X7	7	3/8	11/16	1-1/4	6.80
MP253X8-1/2	8-1/2	3/8	11/16	1-1/4	8.03
MP253X10	10	3/8	11/16	1-1/4	9.14
MP253X11-1/2	11-1/2	3/8	11/16	1-1/4	10.41
MP253X13	13	3/8	11/16	1-1/4	11.53

# Brass Extension Plugs

- Specifications For Extension Plugs Listed Below Are Found On Next Page •
- Longer Lengths Or Special Extensions Are Available •

300 Series					
Part Number	(L) Length	Pipe Thread Size	Hex Size	(A)	Price
MP350X2-1/2	2-1/2	1/16	9/16	7/8	3.45
MP350X4	4	1/16	9/16	1	4.04
Part Number	(L) Length	Pipe Thread Size	Hex Size	(A)	Price
MP351X2-1/2	2-1/2	1/8	9/16	7/8	2.95
MP351X4	4	1/8	9/16	1	2.95
MP351X5-1/2	5-1/2	1/8	9/16	1	4.45
MP351X7	7	1/8	9/16	1	4.95
MP351X8-1/2	8-1/2	1/8	9/16	1	6.33
MP351X10	10	1/8	9/16	1	6.85
MP351X11-1/2	11-1/2	1/8	9/16	1	7.86
MP351X13	13	1/8	9/16	1	9.14
Part Number	(L) Length	Pipe Thread Size	Hex Size	(A)	Price
MP352X2-1/2	2-1/2	1/4	9/16	7/8	2.95
MP352X4	4	1/4	9/16	1-1/4	3.35
MP352X5-1/2	5-1/2	1/4	9/16	1-1/4	4.15
MP352X7	7	1/4	9/16	1-1/4	4.95
MP352X8-1/2	8-1/2	1/4	9/16	1-1/4	6.65
MP352X10	10	1/4	9/16	1-1/4	7.95
MP352X11-1/2	11-1/2	1/4	9/16	1-1/4	8.45
MP352X13	13	1/4	9/16	1-1/4	9.25
Part Number	(L) Length	Pipe Thread Size	Hex Size	(A)	Price
MP353X2-1/2	2-1/2	3/8	11/16	1	4.20
MP353X4	4	3/8	11/16	1-1/4	4.45
MP353X5-1/2	5-1/2	3/8	11/16	1-1/4	5.25
MP353X7	7	3/8	11/16	1-1/4	6.28
MP353X8-1/2	8-1/2	3/8	11/16	1-1/4	7.95
MP353X10	10	3/8	11/16	1-1/4	9.09
MP353X11-1/2	11-1/2	3/8	11/16	1-1/4	10.74
MP353X13	13	3/8	11/16	1-1/4	12.38
Part Number	(L) Length	Pipe Thread Size	Hex Size	(A)	Price
MP354X2-1/2	2-1/2	1/2	7/8	1-1/8	5.10
MP354X4	4	1/2	7/8	1-1/2	7.65
MP354X5-1/2	5-1/2	1/2	7/8	1-1/2	7.49
MP354X7	7	1/2	7/8	1-1/2	9.14
MP354X8-1/2	8-1/2	1/2	7/8	1-1/2	10.74
MP354X10	10	1/2	7/8	1-1/2	13.18
MP354X11-1/2	11-1/2	1/2	7/8	1-1/2	15.35
MP354X13	13	1/2	7/8	1-1/2	17.48

# Brass Extension Plugs

- Specifications For Extension Plugs Listed Below Are Found At Bottom Of Page •
- Longer Lengths Or Special Extensions Are Available •

500 Series					
Part Number	(L) Length	Pipe Thread Size	Hex Size	(A)	Price
MP553X2-1/2	2-1/2	3/8	13/16	1-1/8	4.41
MP553X4	4	3/8	13/16	1-3/8	5.10
MP553X5-1/2	5-1/2	3/8	13/16	1-3/8	6.16
MP553X7	7	3/8	13/16	1-3/8	7.49
MP553X8-1/2	8-1/2	3/8	13/16	1-3/8	8.98
MP553X10	10	3/8	13/16	1-3/8	10.58
MP553X11-1/2	11-1/2	3/8	13/16	1-3/8	12.11
MP553X13	13	3/8	13/16	1-3/8	13.50
Part Number	(L) Length	Pipe Thread Size	Hex Size	(A)	Price
MP554X2-1/2	2-1/2	1/2	7/8	1-1/8	5.10
MP554X4	4	1/2	7/8	1-1/2	5.95
MP554X5-1/2	5-1/2	1/2	7/8	1-1/2	7.23
MP554X7	7	1/2	7/8	1-1/2	8.95
MP554X8-1/2	8-1/2	1/2	7/8	1-1/2	10.63
MP554X10	10	1/2	7/8	1-1/2	12.64
MP554X11-1/2	11-1/2	1/2	7/8	1-1/2	14.35
MP554X13	13	1/2	7/8	1-1/2	16.26

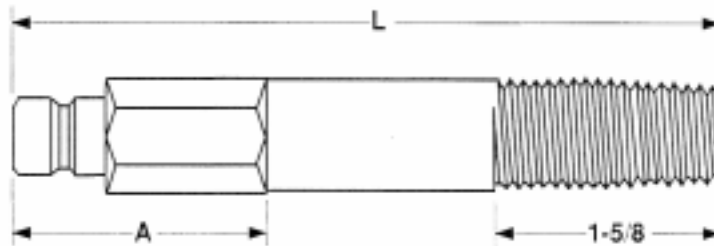

Extension Series	(D) Counterbore	(B) Depth
250	3/4	1
251	7/8	1-1/4
252	1	1-1/2
253	1-1/8	1-1/2
350	1	1-1/4
351	1	1-1/4
352	1	1-1/2
353	1-1/8	1-1/2
354	1-1/2	1-3/4
553	1-3/8	1-5/8
554	1-1/2	1-3/4

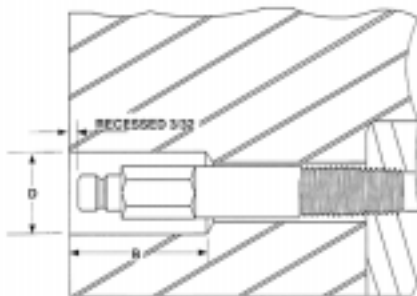

Standard Pipe Thread Data							
Pipe Size	Threads Per Inch	O.D.	I.D.	Tap Drill Size		Minimum Tap Drill Depth	Normal Thread Engage For Tight Joint
				W/O Ream	W/ Ream		
1/16	27	.312	.209	1/4	15/64	9/16	.261
1/8	27	.405	.269	11/32	21/64	5/8	.263
1/4	18	.540	.364	7/16	27/64	13/16	.395
3/8	18	.675	.493	37/64	9/16	7/8	.407
1/2	14	.840	.622	23/32	11/16	1-1/16	.534
3/4	14	1.050	.824	29/32	57/64	1-1/16	.545
1	11-1/2	1.315	1.049	1-9/64	1-1/8	1-3/8	.661