

The various style heaters on pages 520 through 524 are direct replacements for heaters in many OEM applications. This type and construction also lends itself to be easily and economically engineered into new equipment. This design consists of tubular heating elements silver brazed or TIG welded to a flange cut from steel or stainless steel plate. Flange plate size, thickness and shape are determined by the application. A fiber gasket is supplied with each heater.

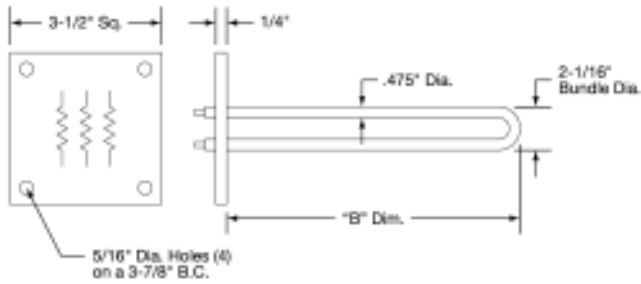

3-1/2" Square Steel Flange		Incoloy 800 Elements				
Part Number	Number of Elements	Immersion Length Inches	Volts 3PH - Y	KW	Watts per Square Inch	Price
TPN01400	3	12.4375	240	1.5	15	272.05
TPN01401	3	12.4375	480	1.5	15	272.05
TPN01173	3	12.4375	240	2.5	24	272.05
TPN01174	3	12.4375	480	2.5	24	272.05
TPN01402	3	12.4375	575	2.5	24	272.05
TPN01403	3	12.4375	240	3	31	272.05
TPN01404	3	12.4375	480	3	31	272.05
TPN01405	3	12.4375	575	3	31	272.05
TPN01175	3	17.875	240	3.5	24	284.75
TPN01201	3	17.875	480	3.5	24	284.75
TPN01406	3	17.875	575	3.5	24	284.75
TPN01407	3	17.875	240	4	27	284.75
TPN01176	3	17.875	480	4	27	284.75
TPN01408	3	17.875	575	4	27	284.75
TPN01409	3	17.875	240	5	34	284.75
TPN01410	3	17.875	480	5	34	284.75
TPN01411	3	17.875	575	5	34	284.75
3-1/2" Square Steel Flange		Steel Elements				
Part Number	Number of Elements	Immersion Length	Volts 3PH - Y	KW	Watts per Square Inch	Price
TPN01351	3	12.4375	240	2.5	24	246.75
TPN01373	3	12.4375	480	2.5	24	246.75
TPN01311	3	17.875	240	3.5	24	259.45
TPN01412	3	17.875	480	3.5	24	259.45

# OEM Flanged Heaters

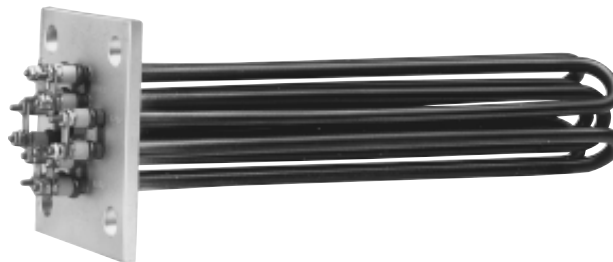
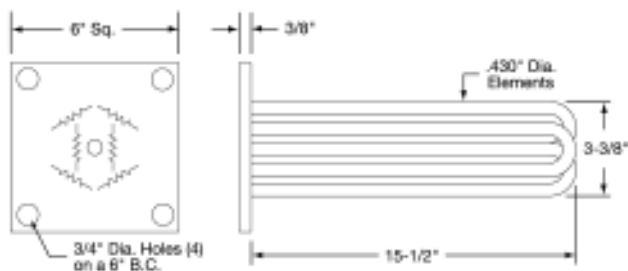

6" Square Steel Flange	Incoloy 800 Elements - 2 Circuits					
Part Number	Number of Elements	Immersion Length Inches	Volts 3PH	KW	Watts per Square Inch	Price
TPN01168	6	15.5	208	9	6.8	360.65
TPN01169	6	15.5	230	9	6.8	360.65
TPN01170	6	15.5	460	9	6.8	360.65
TPN01424	6	15.5	575	9	6.8	360.65
TPN01425	6	15.5	208	10.5	8.1	360.65
TPN01426	6	15.5	230	10.5	8.1	360.65
TPN01427	6	15.5	460	10.5	8.1	360.65
TPN01428	6	15.5	575	10.5	8.1	360.65
TPN01171	6	15.5	208	12	9.3	360.65
TPN01429	6	15.5	230	12	9.3	360.65
TPN01172	6	15.5	460	12	9.3	360.65
TPN01430	6	15.5	575	12	9.3	360.65
TPN01431	6	15.5	208	15	10.9	360.65
TPN01432	6	15.5	230	15	10.9	360.65
TPN01433	6	15.5	460	15	10.9	360.65
TPN01434	6	15.5	575	15	10.9	360.65

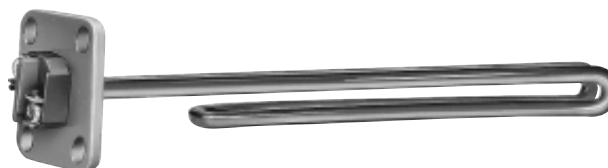
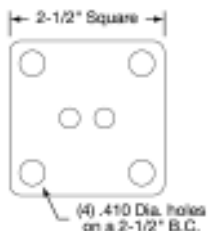

2.5" Square Steel Flange	Incoloy 800 Elements					
Part Number	Number of Elements	Immersion Length Inches	Volts	KW	Watts per Square Inch	Price
TPN01484	1	9.5	240	1	70	40.85
TPN01485	1	11	120	1.25	70	41.35
TPN01486	1	11	240	1.25	70	41.35
TPN01487	1	7.375	120	1.5	70	40.55
TPN01488	1	7.375	240	1.5	70	40.55
TPN01489	1	9	120	2	70	40.85
TPN01490	1	9	240	2	70	40.85
TPN01491	1	10.75	240	2.5	70	41.35
TPN01167	1	12.3125	240	3	70	41.80
TPN01492	1	13.75	240	3.5	70	42.15
TPN01493	1	15.75	240	4	70	42.45
TPN01494	1	16.25	240	4.5	70	43.05
TPN01287	1	19	240	5	70	43.50

# OEM Flanged Heaters

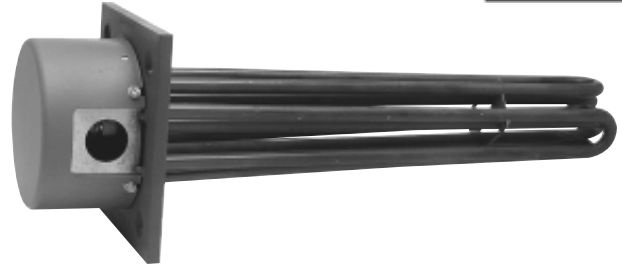
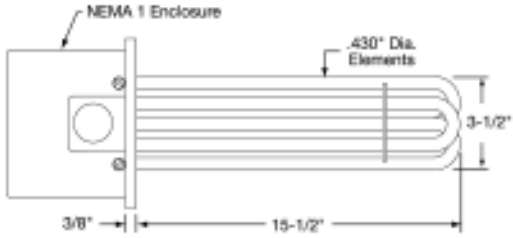
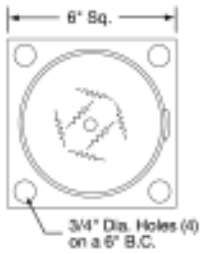

6" Square Steel Flange	Incoloy 800 Elements					
Part Number	Number of Elements	Immersion Length Inches	Volts 3PH	KW	Watts per Square Inch	Price
TPN01413	6	15-1/2	208	4.5	3.1	385.85
TPN01414	6	15-1/2	240/480	4.5	3.1	385.85
TPN01415	6	15-1/2	208	9	6.2	385.85
TPN01416	6	15-1/2	240/480	9	6.2	385.85
TPN01417	6	15-1/2	575	9	6.2	385.85
TPN01418	6	15-1/2	208	10.5	7.3	385.85
TPN01419	6	15-1/2	240/480	10.5	7.3	385.85
TPN01420	6	15-1/2	575	10.5	7.3	385.85
TPN01421	6	15-1/2	208	12	8.4	385.85
TPN01422	6	15-1/2	240/480	12	8.4	385.85
TPN01423	6	15-1/2	575	12	8.4	385.85

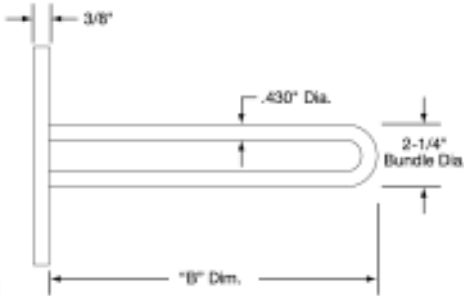
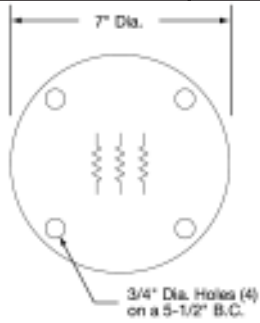

7" Diameter Steel Flange	Incoloy 800 Elements					
Part Number	Number of Elements	Immersion Length Inches	Volts	KW	Watts per Square Inch	Price
TPN01460	3	17.625	240 1PH	3	24	349.25
TPN01461	3	17.625	240 1PH	3	24	349.25
TPN01462	3	17.625	480 1PH	3	24	349.25
TPN01463	3	17.625	480 1PH	3	24	349.25
TPN01347	3	12.375	240 1PH	4.5	50	335.35
TPN01339	3	12.375	240 1PH	4.5	50	335.35
TPN01464	3	12.375	480 1PH	4.5	50	335.35
TPN01465	3	12.375	480 3PH	4.5	50	335.35
TPN01348	3	17.875	240 1PH	9	70	349.25
TPN01198	3	17.875	240 3PH	9	70	349.25
TPN01349	3	17.875	480 1PH	9	70	349.25
TPN01223	3	17.875	480 3PH	9	70	349.25
TPN01304	3	22.875	240 3PH	12	70	364.45
TPN01466	3	22.875	480 1PH	12	70	364.45
TPN01467	3	22.875	480 3PH	12	70	364.45

# OEM Flanged Heaters

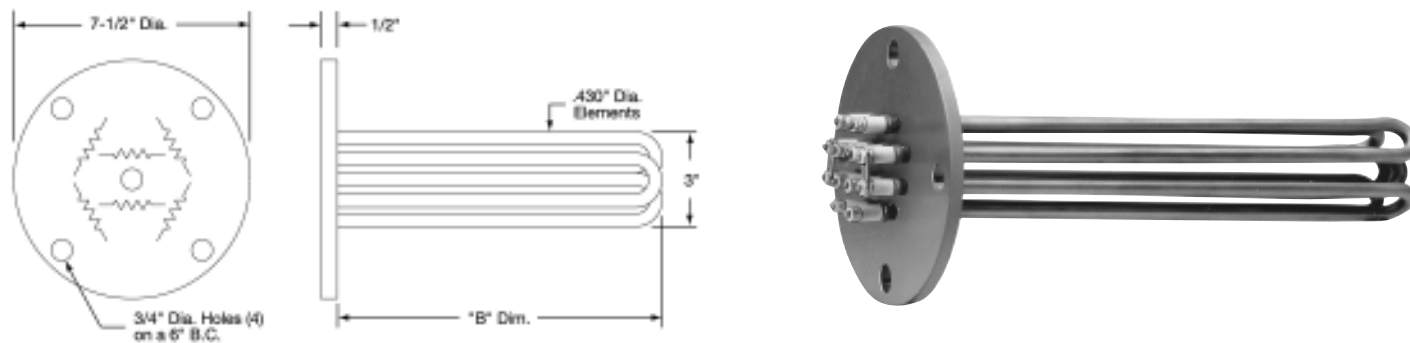

7-1/2" Diameter Steel Flange	Incoloy 800 Elements					
Part Number	Number of Elements	Immersion Length Inches	Volts 3PH - Y	KW	Watts per Square Inch	Price
TPN01468	6	12	208	7.5	50	461.80
TPN01165	6	12	240	7.5	50	461.80
TPN01469	6	12	480	7.5	50	461.80
TPN01470	6	15.875	208	9	42	476.15
TPN01350	6	15.875	240	9	42	473.15
TPN01211	6	15.875	480	9	42	476.15
TPN01471	6	15.875	208	10	50	473.15
TPN01472	6	15.875	240	10	50	476.15
TPN01473	6	15.875	480	10	50	473.15
TPN01474	6	15.875	208	12	53	476.15
TPN01475	6	15.875	240	12	53	473.15
TPN01476	6	15.875	480	12	53	473.15
7-1/2" Diameter Steel Flange	Copper Elements					
Part Number	Number of Elements	Immersion Length	Volts 3PH - Y	KW	Watts per Square Inch	Price
TPN01477	6	15.875	208	9	42	455.45
TPN01478	6	15.875	240	9	42	455.45
TPN01479	6	15.875	480	9	42	455.45
TPN01480	6	15.875	208	10	50	455.45
TPN01481	6	15.875	240	10	50	455.45
TPN01260	6	15.875	480	10	50	455.45
TPN01482	6	15.875	208	12	53	455.45
TPN01483	6	15.875	240	12	53	455.45
TPN01299	6	15.875	480	12	53	455.45

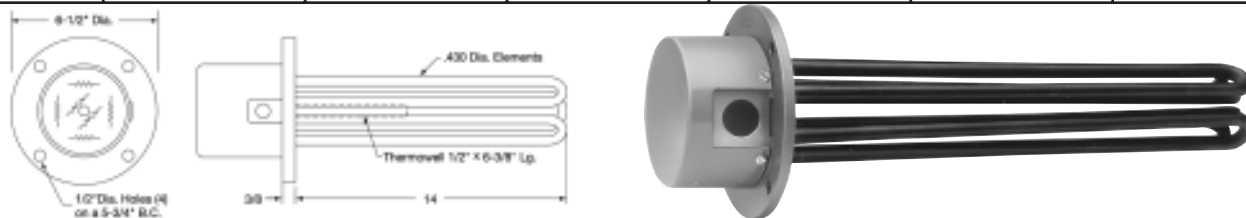

6-1/2" Diameter Steel Flange	Incoloy 800 Elements					
Part Number	Number of Elements	Immersion Length Inches	Volts 3PH	KW	Watts per Square Inch	Price
TPN01706	6	14	460	9	46	449.15
TPN01707	6	14	460	12	62	449.15

# OEM Flanged Heaters

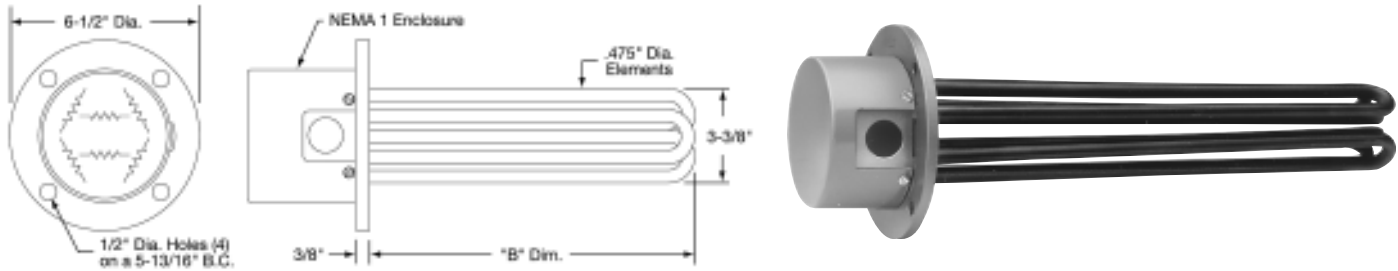

6-1/2" Diameter Steel Flange		Incoloy 800 Elements - 2 Circuits				
Part Number	Number of Elements	Immersion Length Inches	Volts 3PH	KW	Watts per Square Inch	Price
TPN01448	6	17	208	9	50	461.80
TPN01177	6	17	230	9	50	461.80
TPN01178	6	17	460	9	50	461.80
TPN01449	6	17	575	9	50	461.80
TPN01450	6	17	208	10.5	42	461.80
TPN01451	6	17	230	10.5	42	461.80
TPN01452	6	17	460	10.5	42	461.80
TPN01453	6	17	575	10.5	42	461.80
TPN01454	6	17	208	12	50	461.80
TPN01204	6	17	230	12	50	461.80
TPN01179	6	17	460	12	50	461.80
TPN01455	6	17	575	12	50	461.80
6-1/2" Diameter Steel Flange		Copper Elements - 2 Circuits				
Part Number	Number of Elements	Immersion Length	Volts 3PH	KW	Watts per Square Inch	Price
TPN01319	6	17	208	12	48	423.85
TPN01456	6	17	230	12	48	423.85
TPN01321	6	17	460	12	48	423.85
TPN01457	6	28	208	15	70	449.15
TPN01458	6	28	230	15	70	449.15
TPN01459	6	28	460	15	70	449.15

# Replacement Immersion Heaters

Replacement Immersion Heaters for Mold Temperature Control Units.

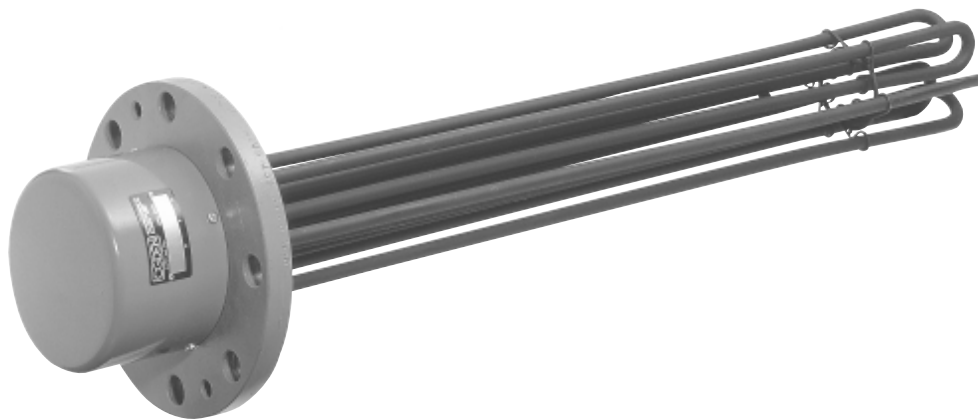

The immersion heaters listed on the following pages are manufactured to OEM specifications. The (B) dimension specified in the chart is the immersion length from either directly under the flange on flanged immersion heaters or from under the bottom of the threads on a pipe plug immersion heater. Any questions on replacement mold temperature control immersion heaters should be directed to a customer service representative at BMS.



# Replacement Immersion Heaters



Mold Temperature Control Replacement Immersion Heaters							
Make	OEM Part #	BMS Part #	(B) Immersion Length	Wattage	Volts @ 3ø	Price	
Advantage Engineering	3785000	K2.5A-3-0003-M0	17-3/4"	9000	240		
		K2.5A-3-0004-M0			480		
AEC		K2A-3-0028	15-3/4"	4500	208	C a l l  f o r  P r i c i n g	
		K2A-3-0027			240		
	103619	K2A-3-0026			480		
		K2A-3-0020			575		
	103620	K2A-3-0031			28"		9000
	103621	K2A-3-0002	480				
		K2A-3-0078	575				
		K3A-6-0078	15-1/2"	9000	208		
	103767	K3A-6-0071			240		
		K3A-6-0107			380		
	103766	K3A-6-0069			480		
	103768	K3A-6-0075			575		
		K3A-6-0085			6000		208
		K3A-6-0106					380
	103819	K3A-6-0089			12000		480
		K3A-6-0077					575
		K3S-6-0136			22"		6000
	104140	K3S-6-0072	240				
		K3S-6-0105	380				
	104139	K3S-6-0073	480				
		K3S-6-0010	575				
		K3A-6-0094	32"	12000	240		
		K3A-6-0093			480		
		K3S-6-0108	54"	18000	240		
	507990	K3S-6-0170			480		
	507989	K3S-6-0173		24000	240		
	507991	K3S-6-0171			480		
	503482	KP-6-0278			9000		240
	503483	KP-6-0277	480				
		KP-6-0282	14-1/2"	12000	208		
503481	KP-6-0280	240					
503486	KP-6-0279	480					
536631	KP-6-0340	17-1/4"		9000	208		
534093	KP-6-0293				230		
536632	KP-6-0316		380				
534092	KP-6-0275		460				
535354	KP-6-0294		575				



1061 Industrial Parkway, Medina, Ohio 44256, U.S.A.  
 Phone: 330-722-1182 • Toll Free: 800-345-7693  
 Fax: 330-725-2723 • Toll Free Fax: 800-581-9264  
 E-mail: customerservice@bmsburns.com

**ORDER TOLL FREE**  
**1-800-345-7693**

# Replacement Immersion Heaters

Mold Temperature Control Replacement Immersion Heaters								
Make	OEM Part #	BMS Part #	(B) Immersion Length	Wattage	Volts @ 3ø	Price		
Brown	543A01290	KP-3-0025-M0	19"	6000	240	<b>C</b>		
	543A00800	KP-3-0021-M0			480			
	543A01300	KP-3-0026-M0			600			
	543X00800	KP-3-0030-M0			480			
Conair	209-333-01	K2.5A-3-0001-M0	12-3/4"	4500	240	<b>a</b>		
	209-333-02	K2.5A-3-0002-M0			480			
	209-333-03	K2.5A-3-0041-M0			575			
	209-333-04	K2.5A-3-0003-M0	17-3/4"	9000	240	<b>l</b>		
	209-333-05	K2.5A-3-0004-M0			480			
	209-333-06	K2.5A-3-0005-M0			575			
	209-333-07	K2.5A-3-0006-M0		12000	240			
	209-333-08	K2.5A-3-0007-M0			480			
	209-333-09	K2.5A-3-0042-M0			575			
	209-333-10	K5A-6-0068-M1		18000	240		<b>f</b>	
	209-333-11	K5A-6-0069-M1			480			
	209-333-12	K5A-6-0070-M1			575			
	209-333-13	K5A-9-0071-M1	27000	240	<b>o</b>			
	209-333-14	K5A-9-0072-M1		480				
	209-333-15	K5A-9-0073-M1		575				
	209-333-16	K2C-3-0011-M0	14-1/2"	4500	240	<b>r</b>		
	209-333-17	K2C-3-0012-M0			480			
	209-333-18	K2C-3-0013-M0			575			
	209-333-19	K2C-3-0006-M0	23"	9000	240	<b>P</b>		
	209-333-20	K2C-3-0007-M0			480			
	209-333-21	K2C-3-0014-M0			575			
	209-333-22	K2C-3-0015-M0		12000	240			
	209-333-23	K2C-3-0008-M0			480			
	209-333-24	K2C-3-0016-M0			575			
	209-333-25	K5C-6-0066-M1		18000	240		<b>r</b>	
	209-333-26	K5C-6-0067-M1			480			
	209-333-27	K5C-6-0007-M1			575			
	209-333-28	K5C-9-0074-M1		27000	240			<b>i</b>
	209-333-29	K5C-9-0075-M1			480			
	209-333-30	K5C-9-0076-M1	575					
	209-449-01	KP-6-0047-M1	16-1/2"	12000	230	<b>n</b>		
	209-449-02	KP-6-0046-M1			460			
	209-480-01	KP-6-0064-M1			230			
209-480-02	KP-6-0065-M1	460						
209-480-03	KP-6-0067-M1	575						
209-480-05	KP-6-0090-M1	9000			230		<b>g</b>	
					230			



# Replacement Immersion Heaters

Mold Temperature Control Replacement Immersion Heaters						
Make	OEM Part #	BMS Part #	(B) Immersion Length	Wattage	Volts @ 3ø	Price
Conair	209-480-06	KP-6-0078-M1	16-1/2"	9000	460	C a i l f o r P r i c i n g
	209-483-02	KFX-1-0107	8-5/16"	3000	230 1ø	
	209-483-04	KFX-1-0109			460 1ø	
	209-537-01	KP-3-0300-M0	13"	4000	240	
	209-537-02	KP-3-0301-M1			480	
	209-537-03	KP-3-0343-M0			208	
	209-537-04	KP-3-0344-M0			600	
	209-545-01	KP-6-0201-M0	14"	9000	230	
	209-545-02	KP-6-0197-M0			460	
	209-546-00	KP-6-0262	14-7/16"		230/460	
	209-546-01	KP-6-0263	10-1/2"	6000	230/460	
Logic Devices		KF-2-0116	12-13/16"	1000	240/480	
		KF-2-0117		2000	240/480	
		KF-2-0015		3000	240/480	
Mokon	011-001 <sup>1</sup>	KF-2-0017	12-13/16"	2000	240/480	
	011-001 <sup>2</sup>	KF-2-0149			240/480	
	011-001 <sup>3</sup>	KF-2-0125			240/480	
	011-001 <sup>4</sup>	KF-2-0035		2200	230/460	
	011-002 <sup>5</sup>	KF-2-0116		1000	240/480	
	011-002 <sup>6</sup>	KF-2-0064			230/460	
	<sup>1</sup> Copper elements			<sup>2</sup> Copper elements without leads		<sup>3</sup> Incoloy elements without leads
<sup>4</sup> Incoloy elements		<sup>5</sup> Incoloy elements without leads		<sup>6</sup> Steel sheath		
Sterlco	A722-00043-1	K2S-3-0058	29"	6000	240	
	A722-00043-2	K2S-3-0042			480	
	A722-00043-3	K2C-3-0032		9000	480	
	A722-00043-4	K2A-3-0059		4500	480	
	A722-00043-6	K2S-3-0060		9000	480	
	A722-00043-8	K2C-3-0061	45"		480	
	A722-00044-1	K2C-3-0009	29"	12000	240	
	A722-00044-2	K2C-3-0010			480	
	A722-00044-3	K2C-3-0057		240		
	A722-00044-4	K2C-3-0052		480		
	A722-00044-7	K2C-3-0054	16"	4500	240	
	A722-00044-8	K2C-3-0055			480	
	A722-00044-15	K2C-3-0034-M1	24"	9000	480	
	A722-00051-1	KR-3-0083-M1	32-9/16"	6000	480	
	A722-00051-2	KR-3-0079-M1	23-1/8"	12000	480	
	A722-00051-4	KR-3-0080-M1	25"	6000	240	
	A722-00051-5	KR-3-0084-M1		9000	240	
A722-00051-6	KR-3-0081-M1	12000		240		

# Replacement Immersion Heaters

Mold Temperature Control Replacement Immersion Heaters						
Make	OEM Part #	BMS Part #	(B) Immersion Length	Wattage	Volts @ 3ø	Price
Sterlco	A722-00051-8	KR-3-0061-M1	22-3/8"	9000	240	C a l l  f o r  P r i c i n g
	A722-00051-9	KR-3-0063-M1			480	
	A722-00051-9	KR-3-0048-M1			22-3/8" (STN. STL.)	
	A722-00051-9A	KR-3-0030-M1	24-1/2"	480		
	A722-00051-10	KR-3-0082-M1	11-3/8"	4500	240	
	A722-00051-11	KR-3-0086-M1			480	
	A722-00051-11	KR-3-0033-M1			11-1/4" (STN. STL.)	
	A722-00058-1	K8S-18-0107	56"	60000	240/480	
	A722-00058-2	K8S-18-0108	53-3/4"	50000	240/480	
	A722-00058-5	K8S-18-0109	56"	72000	240/480	
	A722-00086-1	K6C-12-0128	35"		240/480	
	A722-00086-9	K6C-12-0117	22-1/2"	24000	240/480	
	A722-00086-11	K6S-12-0129	28-1/2"	18000	240/480	
	A722-00086-14	K6S-12-0130	33-1/2"	36000	240/480	
	A722-00086-15	K6S-12-0131	47-1/2"		240/480	
	A722-00086-18	K6S-12-0132	33"	24000	240/480	
	A722-00091-1	K5S-6-0226	56"		240/480	
	A722-00091-5	K5S-6-0227	34"	12000	240/480	
	A722-00091-6	K5S-6-0228	28-1/2"	9000	240/480	
	A722-00091-8	K5S-6-0229	34"	12000	240/480	
	A722-00093-5	K6S-15-0133		36000	480	
	A722-00093-6	K6S-15-0134	33"	24000	480	
	A722-00093-7	K6S-15-0099	34"	36000	240	
	A722-00093-8	K6S-15-0219	56"	50000	480	
	A722-00093-22	K6C-15-0116	32"	75000	480	
	A722-00094-1	K5C-6-0223	18"	12000	240/480	
	A722-00094-2	K5C-6-0224	34"	18000	240/480	
	A722-00094-3	K5C-6-0225	33"	24000	240/480	
	A722-00108-1	K3C-6-0263	16"	9000	480	
	A722-00108-2	K3C-6-0262			240	
	A722-00108-3	K3C-6-0273		12000	240	
	A722-00108-4	K3C-6-0274			480	
A722-00126-01	KP-6-0439	9000		460		
A722-00126-02	KP-6-0501			240		
Super-trol	XUF1146020	K4A-6-0005-M7		19-1/2"	11000	480
Tuc		K2C-3-0128-M1	16"	9000	480	
		K2C-6-0129-M1	29"		240	
		K2C-6-0145-M1			480	